

INDUCTION HEATER IN THE ELECTRIC PASTEURISER*

K. Bodziak, R. Goleman, K. Nalewaj

Department of Fundamental Electrical Engineering, Lublin Technical University, Nadbystrzycka 38A
20-618 Lublin, Poland

Accepted March 16, 1998

A b s t r a c t. The paper presents the results of the electromagnetic and thermal computations for the established models of an induction heater in the electric pasteuriser by means of numerical methods. FLUX2D package has been used to analyse the fields. The electromagnetic field distribution is presented in the particular sectors of the heating system. The distribution of electromagnetic properties including power density serve also to determine the temperature field. Electromagnetic and thermal fields have been analysed at various configurations of the heating systems.

K e y w o r d s: pasteuriser, electromagnetic and thermal fields

INTRODUCTION

Recently introduced flow water heaters have become more and more popular for their rapid reaction and low energy consumption. Flow heating as opposed to the accumulation heating consists in current heating of small amounts of water. Because heat loss occurs mainly during the heating process, which is very short, only thin or sometimes no insulation is needed. Three groups of heaters are distinguished: resistance, electrode and induction heaters.

A resistance pipe element that is the most

frequently used is introduced directly to the water. These resistance heaters are small, easy to manufacture, easily operated and require low production costs. However, the deposits set on the heating elements strain the heat transfer, damage the elements and cause hazards to the users.

Pasteurisers incorporate flow heating electric elements. The processes in the pasteurisers are as follows: first heating, then maintaining some constant temperature for a certain period. Electric pasteurisers are a kind of heat exchangers equipped with a heating system consisting of plunger heaters with sufficient power.

Milk pasteurisers work in rooms with high humidity. High reliability and safety of operation must be maintained. Unfortunately, the method of a water pipe plant system does not usually meet these requirements and frequent failures followed by inconvenient removal of these elements are very troublesome.

There is an idea to install induction heating systems in milk pasteurisers. The assumption is that this kind of heaters work failure-free for many years at full safety and are protected against breakdowns in the water plant system.

A PASTEURISER EQUIPPED WITH A RESISTIVE HEATING ELEMENT

SPOMASZ - a company in Belżyce, is a manufacturer machines and devices for food industry. They produce electric pasteurisers equipped with a circulating water heater equipped with resistive heating elements. This way the company meets the requirement of small enterprises that do not have their own heat-generating plants.

Such pasteurisers consist of the following basic elements: a flat plate heat exchanger made of acid - resistant steel, a circulating water heater with the capacity of 12 l equipped with four dipped heaters of 3125 W each, a coil pipe accumulator, milk pumps, water pumps and a control system that is to maintain some stable temperature for the pasteurised product. Figure 1 presents the layout of the pasteuriser described. The above milk pasteuriser works at high humidity. Resistive heating elements get damaged very often and cause hazards for the operators because of breakdowns. These fre-

quent failures and troublesome replacements cause substantial inconvenience in their operation. The paper presents a few different designs for the heating of flowing fluids with the use of the induction methods.

SELECTION AND OPTIMISATION OF AN INDUCTION HEATER

Induction heaters are bigger than resistance heaters. That is why optimisation of the selection method for the induction heating system selection is so significant to keep them as small as possible.

Flow fluid heating systems must provide:

- small inductors,
- comparatively large contact surface between the elements and the fluid,
- high efficiency.
- durability and safety of operation.

Heating inductors equipped with a winding in a tight steel housing that is dipped in fluid can provide almost 100% heating efficiency. With

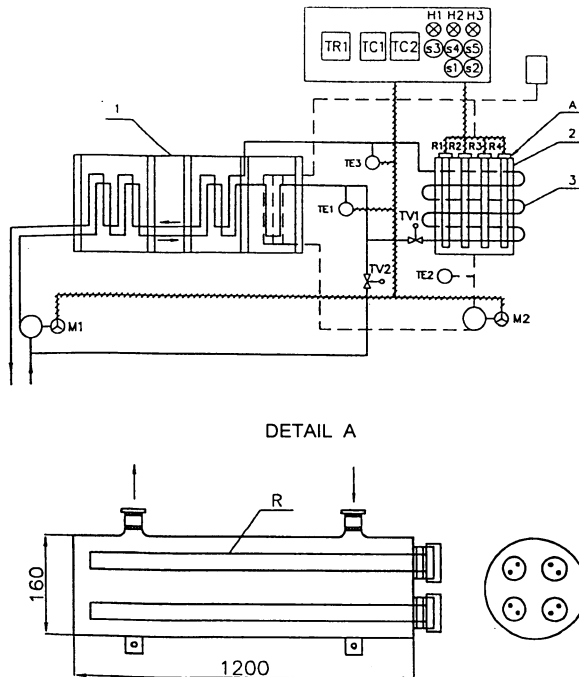

Fig. 1. A pasteuriser equipped with resistive heating elements: 1 - flat plate heat exchanger, 2 - hot water tank, 3 - coil pipe, M1 - milk pump, M2 - circulating water pump, R1, R2, R3, R4 - dipped heaters, TV1 - cycle valve, TV2 - circulation valve, TE1, TE2, TE3 - temperature sensors, TR1 - temperature recorder, TC1, TC2 - thermoregulators, S1, S2, S3, S4, S5 - control buttons, H1, H2, H3 - signal lamps.

this way of heating, fluid temperature is lower than the temperature of the winding conductor in the inductor. The first system described in this paper is the one of the induction heater in an enclosure working in the flowing fluid (Fig. 2). Some special attention has been drawn to the possibly high concentration of the heating power at the limited temperature in the inductor winding.

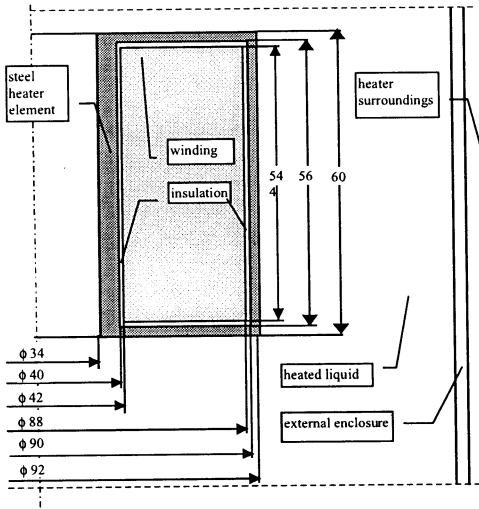

Fig. 2. Cross-section of a prototype heater segment.

The vector of magnetic potential of the prototype heater segment can be described as follows:

- in the winding

$$\frac{\partial^2 \underline{A}_\theta}{\partial r^2} + \frac{1}{r} \frac{\partial \underline{A}_\theta}{\partial r} - \frac{\underline{A}_\theta}{r^2} + \frac{\partial^2 \underline{A}_\theta}{\partial z^2} = -\mu_o \underline{J}_\theta, \quad (1)$$

- in the steel heater element

$$j\omega\gamma l_\theta \underline{A}_\theta + rot[(1/\mu)l_z(\frac{\partial \underline{A}_\theta}{r} + \frac{\partial \underline{A}_\theta}{\partial r}) + (1/\mu)l_r \frac{\partial \underline{A}_\theta}{\partial z}] = 0, \quad (2)$$

- in the heater surrounding

$$\frac{\partial^2 \underline{A}_\theta}{\partial r^2} + \frac{1}{r} \frac{\partial \underline{A}_\theta}{\partial r} - \frac{\underline{A}_\theta}{r^2} + \frac{\partial^2 \underline{A}_\theta}{\partial z^2} = 0, \quad (3)$$

where: ω - angular frequency, μ_o, μ - magnetic permeability of the medium, γ - conductivity of the heater element, \underline{J}_θ - complex current density, \underline{A}_θ - complex component of the vector magnetic potential standard for the model cross-section.

This established numerical model contains an infinity region that makes magnetic field computations possible outside the heater at the Dirichlet condition in infinity. On the boundary of the initial domain, the cyclic conditions has been established and on the symmetry axis - the zero Dirichlet condition.

The electromagnetic field has been determined by means of FLUX 2D [3, 4]. The mesh of 9520 finite elements has been generated (Fig. 3). Material constants for the particular areas have been established and the nonlinearity of magnetisation for the steel housing of the heater which is the heating element made of ST5 steel, has been taken into account.

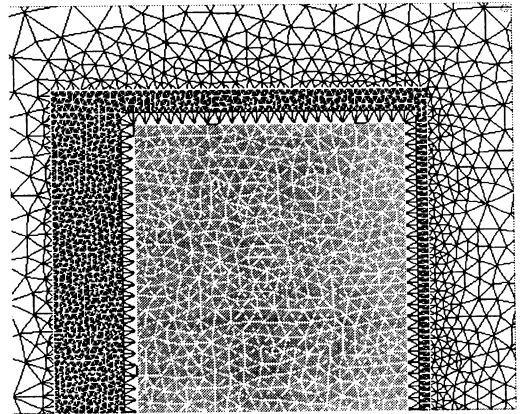

Fig. 3. Finite element discretization of the prototype heater segment.

Computations have been carried out at different current density levels in the windings. Figures 4 and 5 present exemplary simulations at 3 A/mm². The magnetic field and the induced rotary currents are concentrated in the inner wall in the zone near the winding (Fig. 4).

Figure 5 presents the volume density distribution of power which can be used to determine the temperature distribution for the thermal computations.

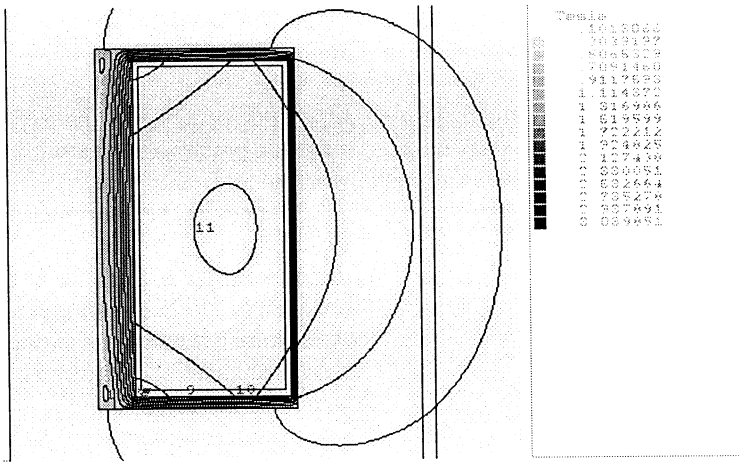

Fig. 4. Magnetic induction and equiflux lines in the heating elements of the pasteuriser

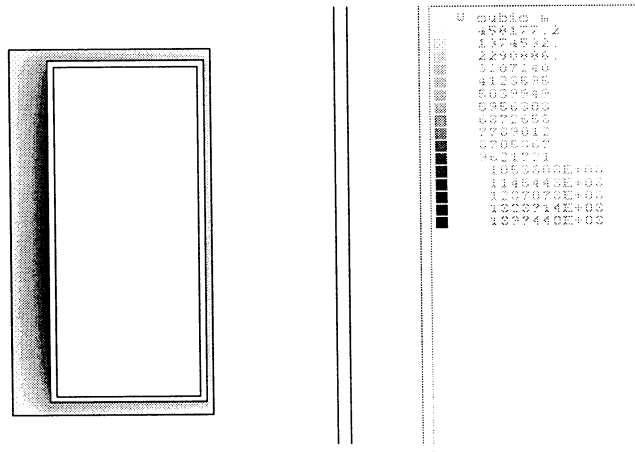

Fig. 5. The volume density distribution of power in a ferromagnetic element.

Power values at the current density in the winding of 3 A/mm^2 computed for the particular areas of the cased heater are given in Table 1.

The computations of power in the individual elements of the heating system indicate that the inner wall of the heaters is decisive for the heating process. This wall must be wide enough.

Table 1. Power values in the elements of the cased heater system

Power	Winding	Steel	External area	Total power	
P	W	-	267.7	-	267.7
Q	Var	58.8	508.6	165	732.5

It is necessary to enlarge the surface that removes the power from the central part of the heater. Similar conclusions have been reached after the tests on the constructed heater model [2]. That is why in this subsequent stage of the analysis another heater with the length of 120 mm has been considered. Its ferromagnetic wall width of the inner element is 5 mm, i.e., 1 mm less than the previous one.

Figures 6 and 7 present the distributions of the magnetic field density and power density for this system at the current density of 4 A/mm^2 in the windings.

This system has a similar spatial distribution in the heater walls as the one with the 60 mm

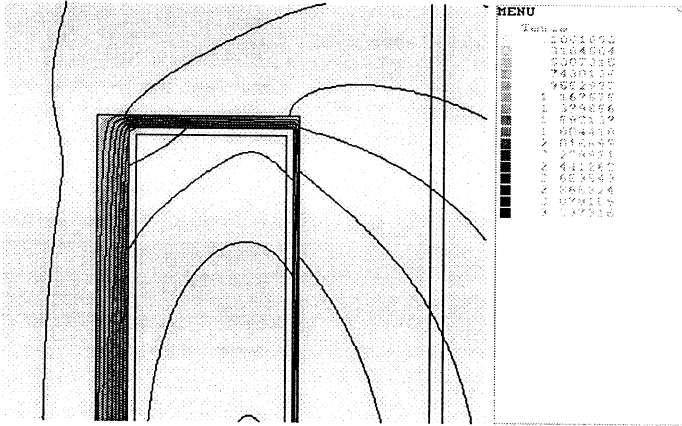

Fig. 6. The distribution of magnetic field density and magnetic field lines in a cased inductive heater segment (120 mm length).

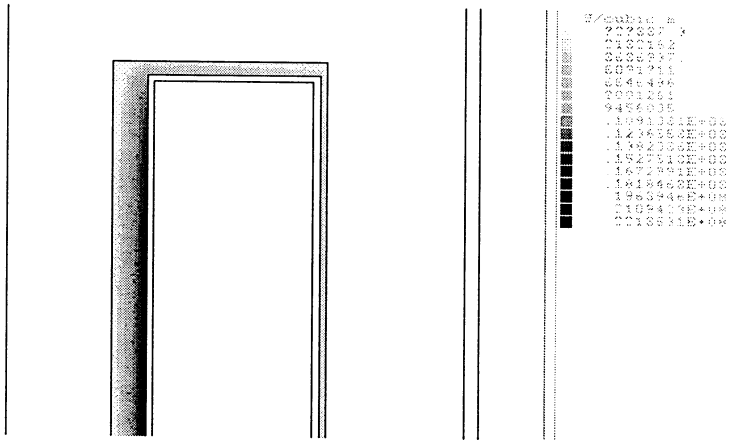

Fig. 7. The volume density distribution of power in a cased inductive heater segment (120 mm length).

length. Its surface that removes the heat from the ferromagnetic element has doubled. The maximum volume density of power has increased by 1.5 and the system active power by about 2.5.

THE INDUCTION HEATER SEGMENT

The theoretical analysis of induction heaters for flowing fluids equipped with mains frequency show that such heaters are competitive at 10 kW. Design assumptions are: total power - 12 kW, three-phase mains supply of 50 Hz for the three identical segments that heat up the fluid up to 100°C over the period of 25 min. Figure 8 presents the lay-out of a cased heater segment [2].

Overall dimensions are $l=400$ mm, $d=160$ mm, $g=4$ mm. The winding is lead DNp2Sh, the insulation is made of silicon saturated glass fibre, temperature limit 180°C. Tank walls (a heated element) are made of steel ST3s. The surface power density is 1.1 W/cm².

The presented inductive heater supplied from the mains is quite big, has a long starting time and a low power factor. The further consideration is focused on the improvement of these parameters.

AN INDUCTION SYSTEM INCORPORATING A HEATING ELEMENT MADE OF NON-MAGNETIC MATERIAL

The use of a double layer heating element can improve the power factor and increase

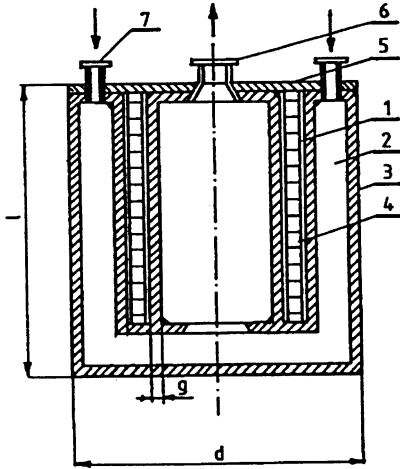

Fig. 8. Induction heater segment: 1 - inductor chamber, 2 - water tank, 3 - tank walls, 4 - inductor winding, 5 - cover, 6 - water inlet, 7 - water outlet.

power density in the heating element [1]. The assumed model of the induction heater incorporates the heating element in the form of a double layer charge with 3 mm width and a 1 mm copper sheet (Fig. 9).

Table 2 presents power values at the current density of 4 A/mm² in the winding computed for the particular areas of the induction heater incorporating a double layer heating element.

The results of our analysis show that power generates mainly in the thin layer of a copper band. However, at these power density levels and because there is no direct contact between the band and the fluid - there is no direct heat transfer from the copper to the water (the copper

band is between the winding and the steel case) - the heat could not be removed from the heating element and from the winding, properly. That is why a new design, presented in Figs 10 and 11, has been proposed. In this new design, the heat is removed by the water directly from the surface of the magnetic bands. These bands (1 mm each) are located inside and outside the inductor. There are magnetic shunts instead of the steel case. The inner shunt is 4 mm wide and the outer one is 5 mm.

Parameters of the heating system with copper bands (Table 3) are characterized by the better power factor, higher heating power and improved power distribution, mainly in the inside part of the heater element when compared with the heater with steel elements.

THERMAL COMPUTATIONS

Thermal computations have been carried out for the system with a non-magnetic heating element (Fig. 10). The temperature distribution is described in the whole space by a partial differential of the Fourier-Kirchhoff's equation:

$$qv + \lambda \nabla^2 T = c_p \rho \frac{\partial T}{\partial \tau} \tag{4}$$

where: q_v - volume density of power, λ - thermal conductivity coefficient, T - temperature, τ - time, c_p - specific heat, ρ - mass density, ∇^2 - laplacian operator in cylindrical co-ordinates.

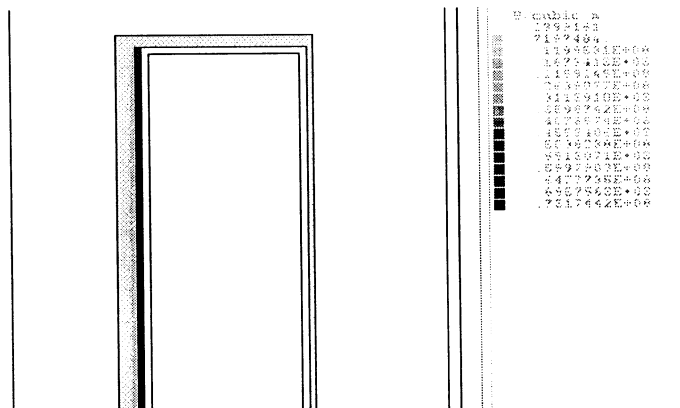

Fig. 9. The volume distribution of power density in an inductive heater segment that incorporates a double layer heating element.

T a b l e 2. Power values in the areas of the induction heater equipped with a double layer heating element

Power		Winding	Copper band	Steel	Heater environment	Total power
P	W	-	973	204	-	1177
Q	Var	309	20.6	949	224	1502.6

T a b l e 3. Power values in the heating element (current density in windings - 4 A/mm²; a, b - elements placed inside and outside the inductor)

Power		Winding	Copper band		Magnetic shunt		Surrounding	Total power
P	W		a	b	a	b		
P	W	-	2022	866	-	-	-	2888
Q	Var	533	35	10	508	~1	699	1786

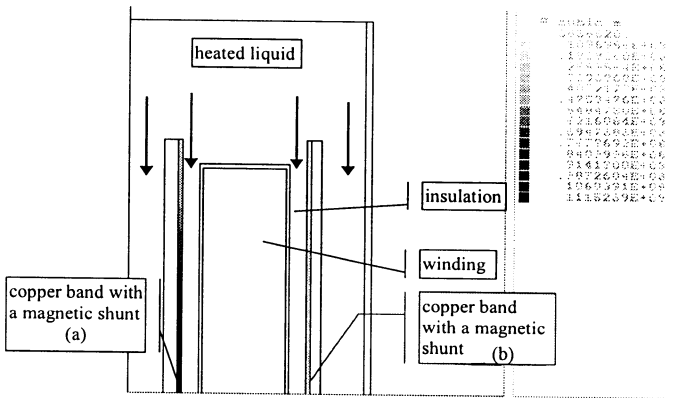

Fig. 10. Volume power density in the copper band of the induction system (the height and the outside diameter of the copper band with the magnetic shunt are 250 mm and 108 mm, respectively).

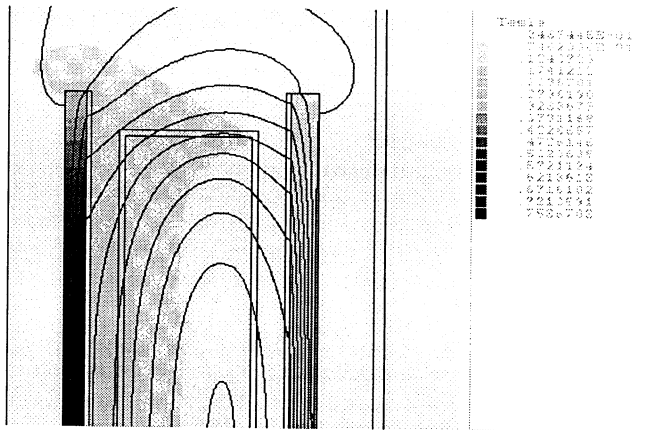

Fig. 11. The distribution of magnetic flux density and fields lines in a segment of the model with a non-magnetic heating element.

A flux 2D package has been used to solve and analyse the fields. The electromagnetic and temperature computations are coupled. Figure 12 presents the layout of the heater with the copper heating element on which L_1 is indicated. This line is in the distance of 1 mm from the inner surface of the element. The temperature distribution at the 30th part of the heating up has been determined along this line. The temperature increase in the internal element causes the water temperature increase, the highest in the area of the direct heat transfer from the internal heating element. Along the L_1 line, water heats up most in the central point of the system. The temperature distributes similarly along the line at the particular points of time but the longer the process, the higher the temperatures are and the less the distribution is distorted. One mm from the outer element surface in the

centre of the system at the 10th s of heating the temperature is about 36^oC. After next 10 s, water temperature rises up to about 60^oC and after the other 10 s - up to 83^oC (Fig.13).

Figure 14 shows the system in which the L line located in the transverse axis is indicated. Figure 15 presents temperature distributions along the L line. The analysed heater heat the water up very quickly in the layer adjacent to the inner heating element but inside the system the heating process is much slower (Fig. 15). This is caused by the slow heat transfer to the subsequent water layers.

This heating process depends on time. The temperature rises are the highest at the beginning. The temperature that can be reached at the same geometry of the system depends on many factors, mainly on the current density in the heater winding. Higher current densities in the

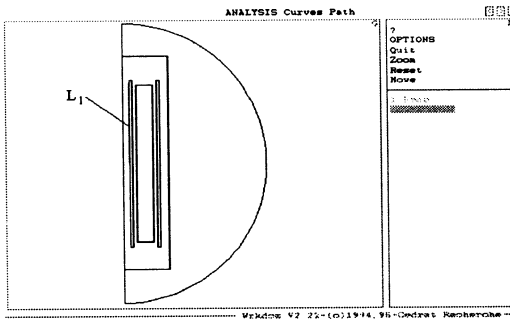

Fig. 12. Cross-section of a non-magnetic inductive heater. L_1 - line placed at the distance of 1mm from the surface of the copper band "a" (Fig.10) on which the distribution of temperature is presented in Fig. 13.

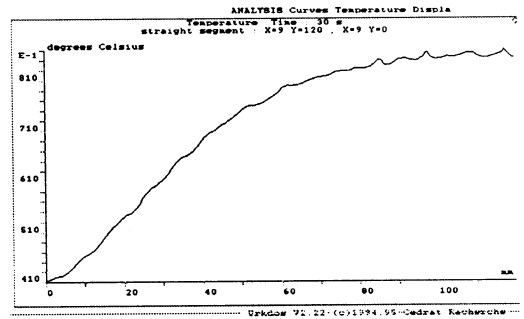

Fig. 13. Temperature distribution along the L_1 line at 30 s.

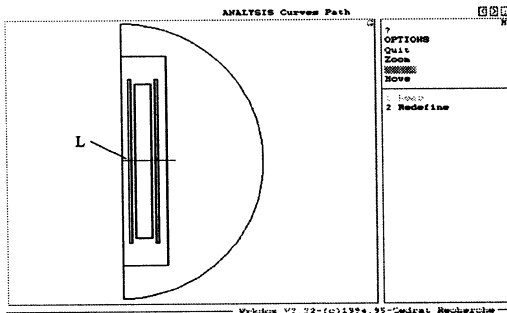

Fig. 14. Cross-section of a non-magnetic inductive heater. L - line across the heater on which distribution of temperature is presented in Fig. 15.

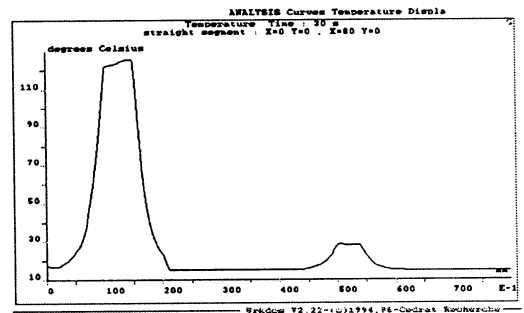

Fig. 15. Temperature distribution along the L line at 30 s.

winding are relevant to higher temperatures in the heating element and thus higher water temperatures but the current density is limited.

CONCLUSIONS

The analysis of the coupled fields in the induction heating systems shows that the use of the induction method instead of the resistance method can be competitive in electric pasteurisers. The cased induction heaters with a steel heating element and supplied with mains frequency are big. The computations indicate that the system incorporating a non-magnetic element in the form of a copper band are small and have high electrothermal efficiency and a relatively high power factor.

The model of the cased induction heater has been constructed. The tests carried out with this

model confirm the conclusions reached from numerical computations that there is the need to apply a double-layer heating element or the heating element made of a non-magnetic material.

REFERENCES

1. **Bodziak K., Goleman R., Nalewaj K.:** The computation of electrical properties in the induction heaters of flowing fluids. Computers application in electrotechnics (in Polish). Poznań-Kiekrz, 123-126, 1997.
2. **Bodziak K., Nalewaj K., Gołowski B.:** Induction heater of flowing fluids. Simulation, measurements and diagnostics in electrothermy (in Polish). III Symposium, Białystok, 37-44, 1994.
3. **Bolkowski S., Stabrowski M., Skoczylas J., Sroka J., Sikora J., Wincenciak S.:** Computer method of electromagnetic field analyses (in Polish). WNT, Warszawa, 1993.
4. **FLUX 2D, Version 7.1.** CAD Package for electromagnetic and thermal analysis. User's Guide. CEDRAT, 1994.